

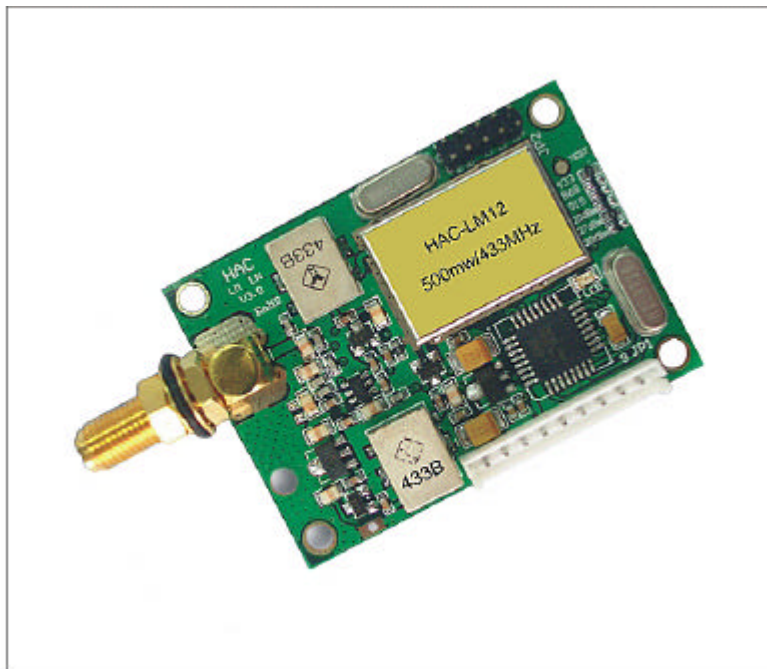

HAC-LM Series Low Power Data Radio Module

Version 3.0



SHENZHEN HAC TELECOM TECHNOLOGY CO., LTD

Address : 3rd Area, 19th Fl, Tower A, HaiSong Building, Tai Ran 9th Rd,
Futian, ShenZhen, China.

Tel : +86-755-23981078 23981077
Fax : +86-755-23981007
E-mail : webmaster@rf-module-china.com
Website : <http://www.rf-module-china.com>



Catalogue

I.	Features of HAC-LM Series	3
II.	Applications of HAC-LM Series.....	4
III.	How to use HAC-LM Series	4
IV.	Networking Application of HAC-LM Series	13
V.	Technical specification of HAC-LM Series.....	14
VI.	Description of type.....	15



I. Features of HAC-LM Series

1. Low power transmission with 500mW, 100mW~1W is available if needed.
2. With 433MHz as factory default carrier frequency, but 402-470MHz is available if needed.
3. High anti-interference and Low BER (Bit error Rate)

Based on the Gaussian Frequency Shift Keying (GFSK) modulation, the high-efficiency forward error correction channel encoding technology is used to enhance data's resistance to both transient interference and random interference and the actual bit error rate of $10^{-5} \sim 10^{-6}$ can be achieved when channel bit error rate is 10^{-2} .

4. Long Transmission Distance

Within the visible range, when the height of antenna is higher than 2m and The Bit Error Rate (BER) is 10^{-3} , the reliable transmission distances respectively is 4500m @1200bps, and is 2000m@9600bps.

5. Transparent data transmission

Transparent data interface used in transceivers is for meeting many standard or nonstandard user protocols. Any false data generated in air can be filtrated automatically (What has been received is exactly what has been transmitted).

6. Multi-channels

HAC-LM transceivers offer 8 channels, if needed, 16 or 32 channels are available to satisfy various configuration of communication under user's demand at the same time

7. 2 ports with three connection methods

HAC-LM transceivers provide 2 ports with three connections, ports: a UART interface of TTL level, a non-standard RS-232 port and a non-standard RS-485 port, which both are defined by user software (define it just by plugging out and in one short circuit device and then power on).

Note: LM384 (i.e. the baud rate is 38400bps) is without any non-standard RS-232/485 port

8. Big data buffer area

With optional interface baud rate: 1200/4800/9600/19200/38400bps and 8N1/8E1 data format (set by user), the transceiver can transmit unlimited data frames with flexible user program.

9. Intelligent data control and no any extra programs required

Even for half duplex communication, no any excessive programs required. All RF system data transmission/reception and other On-the-Fly conversion and control are performed by

HAC-LM transceivers automatically.

10. Lower power consumption & Sleep function

With +5V power, the receiving current is less than 50mA, the transmitting current is less than 400mA, and the sleeping current is less than 5 μ A.

11. High reliability, small and light

By using monolithic radio-frequency integrated circuit and single-chip MCU, the transceivers have less peripheral circuits, high reliability, and low failure rate.

12. More options of configurable antennas for user different applications.

II. Applications of HAC-LM Series

HAC-LM Series Ultra low power data radio module is suitable for:

- * Auto Meter Reading system.
- * Remote control and monitoring.
- * Automatic data collection.
- * Building automatization, security, machine-house equipment wireless monitoring
- * Traffic, Personnel positioning and alarm in the well

III. How to use HAC-LM Series

HAC-LM is a member of HAC series low power data radio modules, which provides RS-232, RS-485 and UART/TTL level interface port for direct connection with PC, RS485 devices, monolithic processors and other UART components kind of applications. The schematic diagram is shown below:

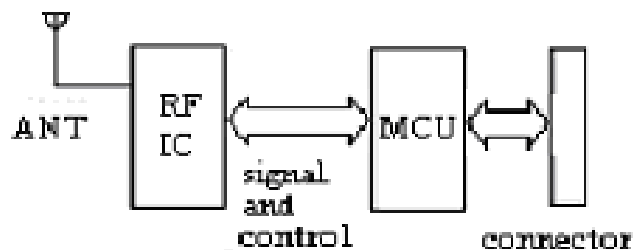

HAC-LM principle map



1. Power supply

The factory default setting is +5.0, $\pm 0.25V$ DC. By using better ripple factor, HAC-LM transceivers can also share power supply with other equipment. If possible, a voltage-stabilizing chip with 5V voltage is more recommended as the only power supply than Switch power supply. But if only switch power supply available, the jam by switch pulse to the transceivers should be avoided. In addition, the reliable grounding must be used if there is other device in the system equipment. In case of failing to connect with the ground, it can form its own grounding but must be absolutely separated from the municipal electric supply.

2. Connection Definition with terminal

HAC-LM transceivers supply one 9-pin connector (JP1), their definitions and connection methods with terminals are shown in Table 1.

Table 1: JP1 Pin Definitions and connection methods

Pin	Signal Name	Function	Level	Connection with terminal	Remarks
1	GND	Power Ground		Power Ground	
2	VCC	Power supply DC	+4.75~5.25V		
3	RxD/TTL	Serial data for receiving terminal	TTL	TxD	
4	TxD/TTL	Serial data for transmitting terminal	TTL	RxD	
5	SGND	Signal Ground			
6	A(TxD)	A of RS-485 (TxD of RS-232)		A(RxD)	
7	B(RxD)	B of RS-485 (RxD of RS-232)		B(TxD)	
8	SLEEP	Sleep control (input)	TTL	Sleep signal	High level sleep
9	RESET	Reset signal (Input)	TTL		Negative pulse reset

3. The connection schematic diagram of HAC-LM transceivers with terminal.

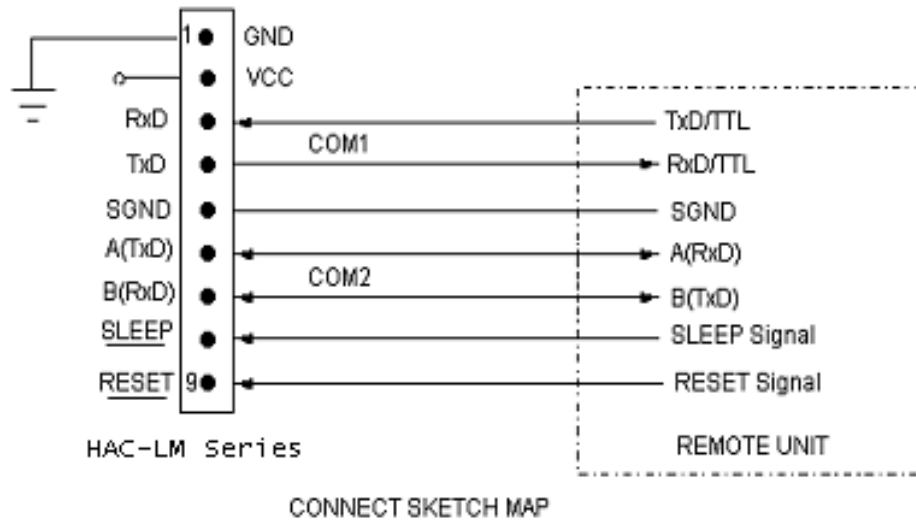

4. Setting of channel, interface and data format:

Before using HAC-LM, the user needs to make simple configuration based on its own needs to determine the channel, interface mode and data format.

There is one group of 5-bit short-circuit jumper wire (JP2) on the upper right corner of HAC-LM, defined as ABCDE respectively. Assuming the open circuit of jumper wire (without short circuiter) is mode 1 and short circuit of jumper wire (with short circuiter) is mode 0, then the configuration is as follows:

a. Channel configuration:

ABC jumper wires of JP2 provide 8 options, and the user can choose to use 0-7 channels through ABC jumper wires. Within one small communication network, as long as ABC jumper wire mode is same, there can be mutual communication.

Table 2: Corresponding frequency points of 0~7 channels

Channel No.	Frequency	Channel No.	Frequency
CBA=000(0)	430.2000 MHz	CBA=100(4)	434.6940 MHz
CBA=001(1)	431.4288 MHz	CBA=101(5)	434.2332 MHz
CBA=010(2)	431.7360 MHz	CBA=110(6)	433.1580 MHz
CBA=011(3)	430.5072 MHz	CBA=111(7)	433.9260MHz

Note: The frequency points corresponding to each channel can be adjusted based on the user's needs.

1=Unplugging short circuiter 0 =Plugging in short circuiter

b. Selection of interface mode:

HAC-LM provides 2 serial ports. COM1 (Pin3 and Pin4 of JP1) is fixed as UART serial port of TTL level; COM2 (Pin6 and Pin7 of JP1) can choose non-standard RS232/485 interface mode through D of JP2:

D=1 (Unplugging short circuiter) COM2 = RS-485

D=0 (Plugging in short circuiter) COM2 = RS-232

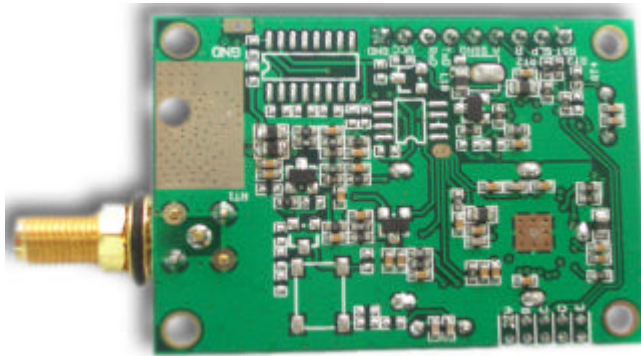
**The following attention should be paid for the two serial ports provided by HAC-LM:**

- i. For the data received from the air, when HAC-LM transmits it to the terminal equipment through serial port, COM1 and COM2 output simultaneously, i.e. if the user connects one device at COM1 and COM2 respectively, they both can receive the data simultaneously.
- ii. For the data transmitted from the terminal equipment and ready to transmit to the air, HAC-LM can only receive the data sent from either COM1 or COM2 but not simultaneously.

Suggestion: The user only use one serial port of COM1 and COM2.

NOTE: A standard interface of RS232 or RS485 is available if needed, but only we are informed when placing orders. All HAC-LM series can have standard RS232 or RS485 as COM2, but only one option is available once, here non-standard RS232 or RS485 is invalidated.

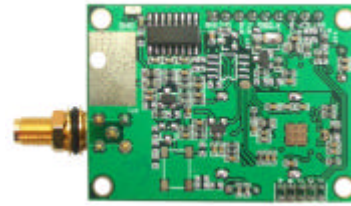
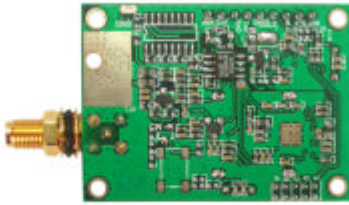

c. Parity mode selection:

HAC-LM can support no-parity or even parity modes of the serial communication UART, i.e. 8N1/8E1, which can be chosen through E of JP2:

E=1 (Unplugging short circuter) Parity: 8E1 (even parity)

E=0 (Plugging in short circuter) Parity: 8N1 (no parity)

NOTE: The communication data rate can not be set by user, it is confirmed when placing orders and set before delivery. The short circuter will be validated by re-powering on if its method of plugging in changed.

5. The Function-indicator light

- a. The LED indicator light glitters for 0.5S once after switched on.
- b. The LED indicator light glitters continually while receiving data from air.
- c. The LED indicator light will light on continuously when the transceiver transmits data into air after receiving from COM.
- d. If the module enables the sleep function, LED indicator light is always dark.

6. Supported protocol and Transmit capability

HAC-LM standard transceivers offer transparent protocol to support various applications and protocols of users. If the user needs to decrease his cost or ease the workload of terminal CPU, we can add other specific functions based on the transparent protocol, such as addressing, data acquisition, command interpretation, etc.

7. Sleep function instruction:

Due to reducing more consumption, HAC-LM transceivers support Sleep function. In sleep mode,

the current consumption is less than $5\mu\text{A}$.

The sleep function is usually closed in default status to ensure the reliability of preventing transceivers from getting in wrong sleep mode. The sleep function can be only opened by HAC after informed by the customer when they put order.

a. How to use the Sleep function:

The Pin8 'SLP' in JP1 is the signal of sleep control. In high power level, when the transceiver stays in sleep mode, the conversion from idle mode to sleep will be finished in 1ms. The SLP signal can convert transceiver from idle to sleep mode in 1ms after rising edge. If the Sleep signal arrives when the transceiver is transmitting data, the module will enter sleep mode after finishing transmission. From sleep mode to idle, it takes the transceiver 10ms after falling edge.

To disable the opened sleep function of HAC-LM, the SLP (SLEEP) pin should be definitely connected with 0 or ground.

b. Attentions about use of sleep function:

When the sleep function enabled, any supply glitches, such as switch dithering, fire striking or quick switching on and off, could cause the transceiver to be switched to the wrong sleep mode. After switching on, users can avoid this error by making a compulsive restoration once after the CPU delays 100ms.

Sleep Timing Diagram:

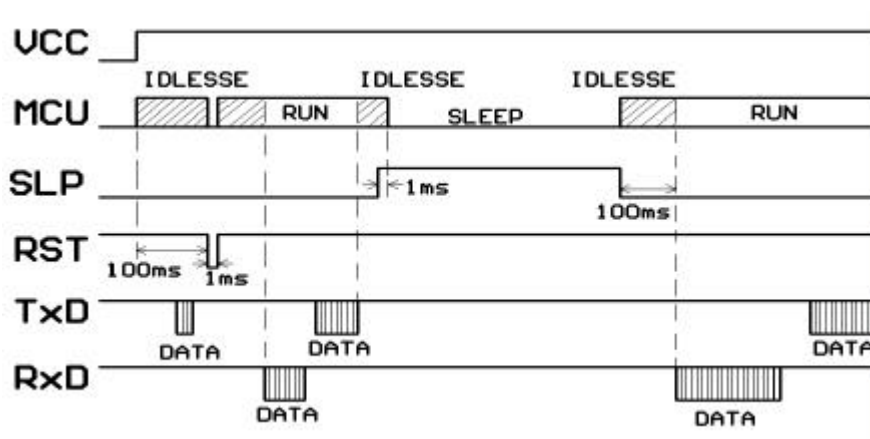

8. The attentions of data transmission

- The delay time (t_c) of conversion between transmitting and receiving is less than 1ms.

Timing diagram:

HAC-LM

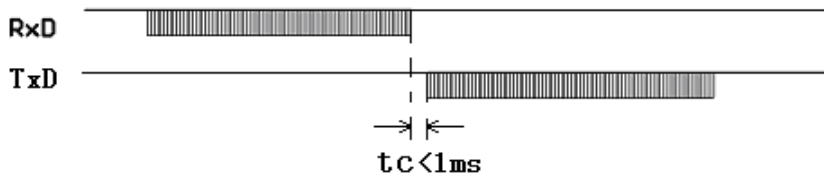

b. The delay time of transceivers between the first bit sent by TxD to the first bit received by RxD.

Due to a data processing will be made on user’s data by HAC-LM transceiver using FEC (Forward Error Correction) or other correction algorithm, when RxD of a HAC-LM transceiver ‘A’ receives the data, then transmits it, the other one transceiver ‘B’ will have a delay (ts) to receive and transmit by TxD. Different RF data rate causes different delay time. Please see the specific delay time below:

Rf Data Rate (bps)	Delay ts (ms)	RF Data Rate (bps)	Delay ts (ms)
1200	90	9600	12
2400	48	19200	6
4800	24	38400	3

Timing diagram:

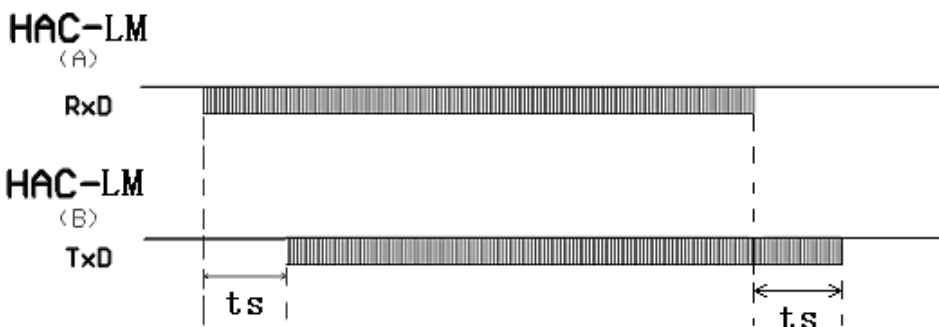

c. Error dealing procedure:

To enhance the reliability and stability of user’s systems, a verify bit or a Cyclic Redundancy Check (CRC) mode is highly recommended to resent the wrong information while using HAC-LM series modules.

**d. Large-number data transmission**

In theory, when the interface data rate is faster than the RF data rate, HAC-LM transceivers can send unlimited-long data package, but any long packages more than 120B are not recommended. The length of each package should be between 60~100B. We also recommend user to resent the wrong information using Automatic Error Request Equipment (ARQ).

The analyzing as below:

What if the actual transmission BER (Bit Error Rate) is 10^{-4} , 1 packet with 1KB data, which is about 10-thousand bits, is sent, theoretically, at least 1 bit will be received wrongly, then the 1KB information will never be received correctly.

But if we package the data into 10 packets with 100B for each, when all 10 packets are sent, there will be only 1 packet wrong according to this probability. After that, resend this wrong packet using ARQ mode. So by resending one more packet and the efficiency rate is reduced 10%, all data will be absolutely received correctly.

9. Dimension diagram (Unit: mm):

The dimension diagram below is the factory set default of HAC-LM transceiver. Other required smaller sizes and different shapes can also be provided.

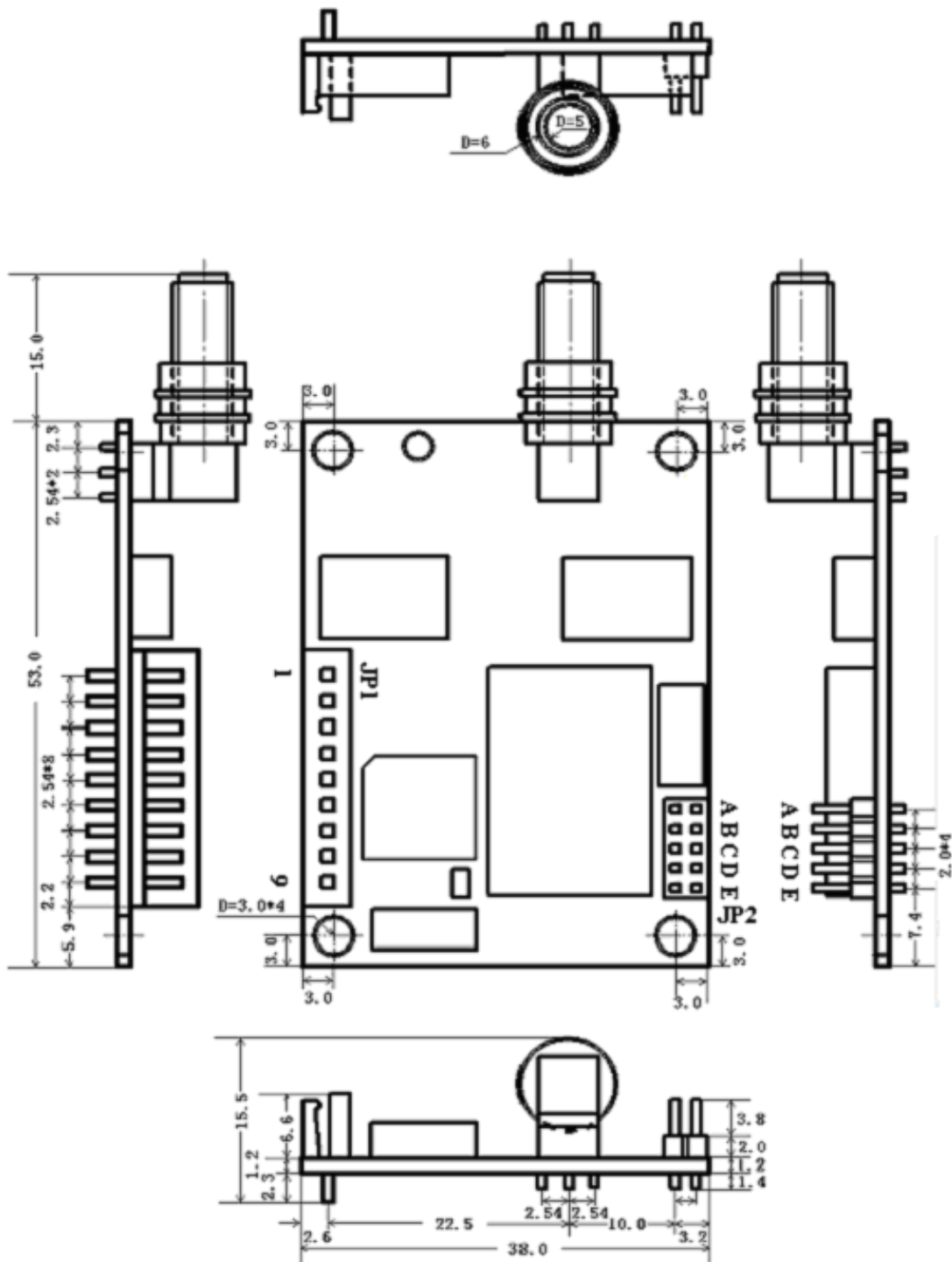

10. Antenna configuration:

Many appropriate antennas for low power RF modules are selected for meeting different user antenna configurations. Please ask our Sales office for further information about the antenna's dimension and performance.



a. Helical SMA antennas

LX433-10-SMA: 100mm helical SMA antennas with high gain and low cost, reach a long distance.



LX433-3-SMA: 35mm SMA helical antenna with magnetic core, small size, beautiful appearance (like the mobile phone antenna)



LX433-10-ZSMA: 100mm SMA helical antenna with folding joint, easy for adjusting the direction and fixing.



b. Magnetic vehicle antenna

XP433-300H-SMA: include magnetic antenna base, suitable for equipment with metal shell, easy for fixing, effective to enhance the transmission distance.



If the user has special demands on antennas, we can design and produce for them specially.

IV. Networking Application of HAC-LM Series

The communication channel of HAC-LM is half duplex, which is most suitable for the communication mode of point to multi-point. Under this mode, one master station must be



set, and all of the rest are slave stations. A unique address is given to each station. The coordination of communication is controlled by master station that uses data frames containing address code to transmit data or command. Slave station will receive all of the data and command and compare the received address code with local address code. If they are different, the data will be deserted without any response. If those address codes are the same, it means the data is sent to the local. Slave station will make different responses according to the transmitted data or command and send back the data of response. All these jobs must be performed by upper protocol, and it is assured that there is only one transmitter-receiver in the state of transmission in the communication network at any instant moment so as to avoid the cross-interference.

HAC-LM can also be used for point-to-point communication with easier operation. For the programming of serial port, all you have to do is to remember that its communication mode is semi duplex while always observing the time sequence of come-and-go for receiving and transmitting.

V. Technical specification of HAC-LM Series

Modulation mode: GFSK

Working frequency: 429.00~434.93MHz

Transmission power: 27dBm (500mW)

(Available Customization frequency 20dBm ~ 30dBm)

Interface data rate: 1200/2400/4800/9600/19200/38400bps, set before delivery.

Receiving sensitivity -123dBm~-116dBm, (-118dBm@9600bps)

Interface data format: 8E1/8N1

Transmit current: <400mA

Receive current: <50mA

Sleeping current: <5 μ A

Working humidity: 10%~90% relative humidity without condensation

Working temperature: -20 ~70 (Commercial) , -40 ~80 (Industrial)

Dimension: 53 × 38 × 10mm

Power supply: 4.75 ~ 5.25VDC (100mW~1W available for special user but they always go with supply voltage 7.2~9V)



VI. Description of type

For product type HAC LM96, “HAC-”indicates the name of manufacturer ShenZhen HAC Technology Co., Ltd., “L” low power, i.e. transmission power is 27dBm, ‘M’ indicates carrier frequency 402~470MHz, the factory default is 433.926MHz, and 96 indicates that interface baud rate is 9600bps. 38400bps type is HAC-LM384.

HAC-LM96

